

Off-Grid Street Light

Maintenance-free, next generation Off-grid street light, works by solar sheet (model: CG0901) and batteries (model: IP1001).



Body color can be changed



Grain pattern Earth green

Features

- Pole-integrated solar generator by wrapping solar sheet.
- Battery units are placed inside the pole. Max. 1024Wh capacities.
- The battery (model IP1001) is safe and maintenance free.
- The wind resistance is maximum 60 m/s.
- Pole will be the independent power source to apply the LED light, security cameras, or Wi-Fi routers. (Custom order)
- Three type body color, Silver, Grain pattern, and earth green.

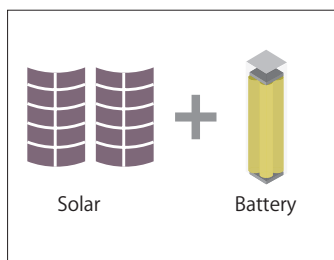

High efficiency and safety

High efficiency solar sheet (model CG0901) and high safety battery (model IP1001) are used.

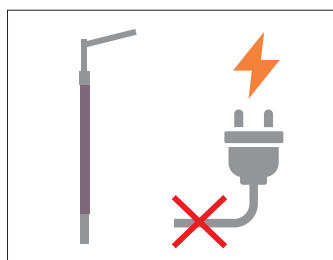

Not required grid system

The independent power source without grid system or electrical work.

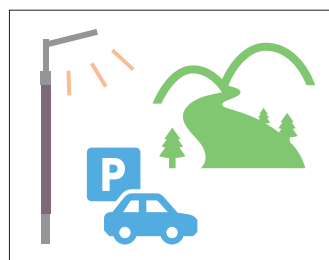

Bright LED light

Make the place safe with LED light, where are difficult to reach the grid system.

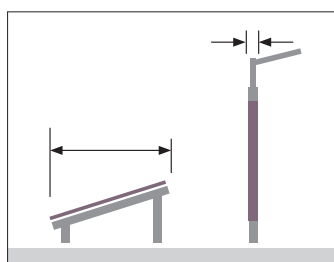

Saving the space

No flat solar panels or battery boxes. This design helps saving space.

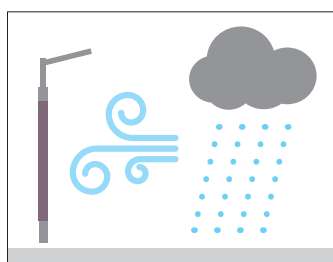

Strong wind resistance

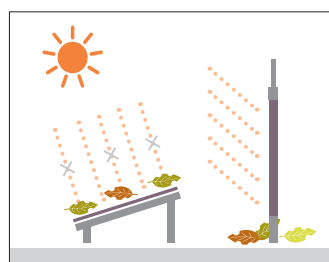

The pole without cable is able to resist the strong wind such as typhoon, hurricane, and cyclone.



High generation stability

The vertically generation surface makes high generation stability and long maintenance-free period not to pile up snow or fall leaves.

Specifications

Model		TFL-3001S	TFL-2001S	TFL-1001S
Product appearance				
Solar	Material	Model:CG0901		
	Maximum output (P Max)	250W	125W	80W
Battery	Material	Model:IP1001		
	Color	S: Silver, M: Grain pattern, G: Earth green		
Body	Dimensions (mm)	φ 280×L4756	φ 190×L4756	φ 190×L3483
	Weight (kg)	150	120	75
	Material (Surface finishing)	Steel pipe Hot-dip galvanization		
	Operation temperature	-10°C~+45°C		
	Wind resistance (Wind Speed)	60m/s		
	Installation	Base plate type		
LED light	Power Consumption (W)	20W	10W	4W
	Color Temperature (K)	6000~6500		
	Luminous flux (LM)	1456	752	274

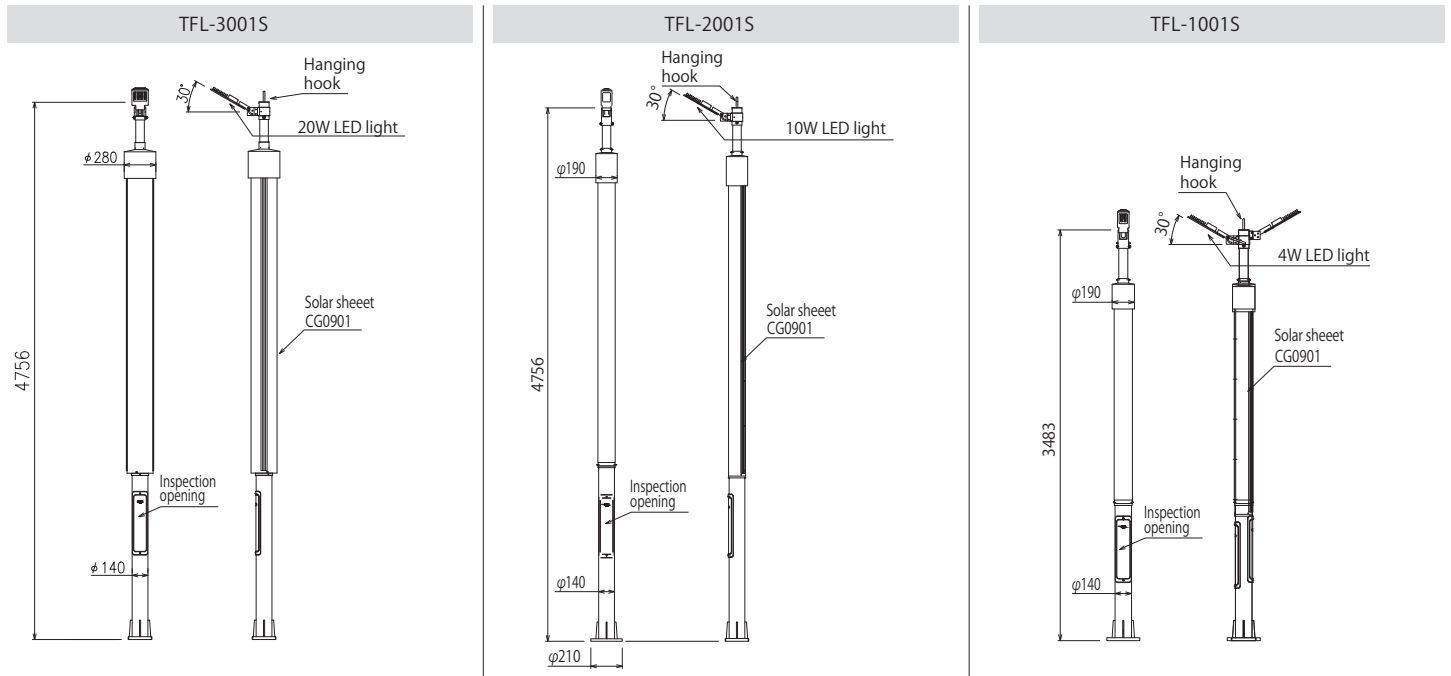

OSI CO., LTD.

OSI CO., LTD.

20th Floor, Wah Hing Commercial Building, 283 Lockhart Road, Wanchai, Hong Kong

<https://hk.os-worldwide.com> info-hk@os-worldwide.com

This catalog is current as of October 2021.

Please note that the product colors appearing in this catalog may vary from the actual item due to the characteristics of the printing process.

Product specifications are subject to change without notes.