

矢視 A - A

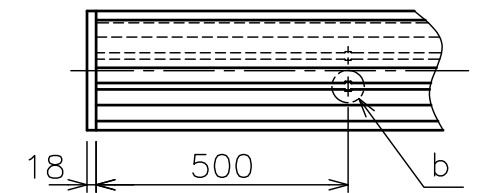

矢視 B

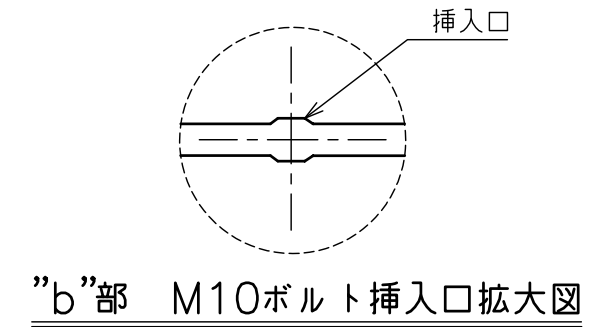
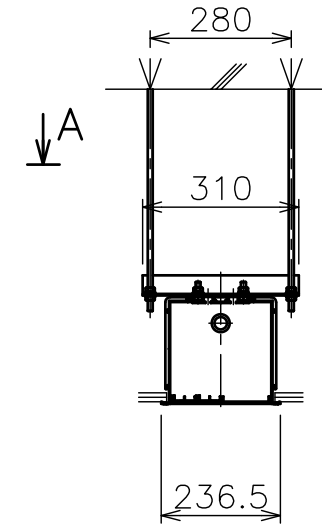
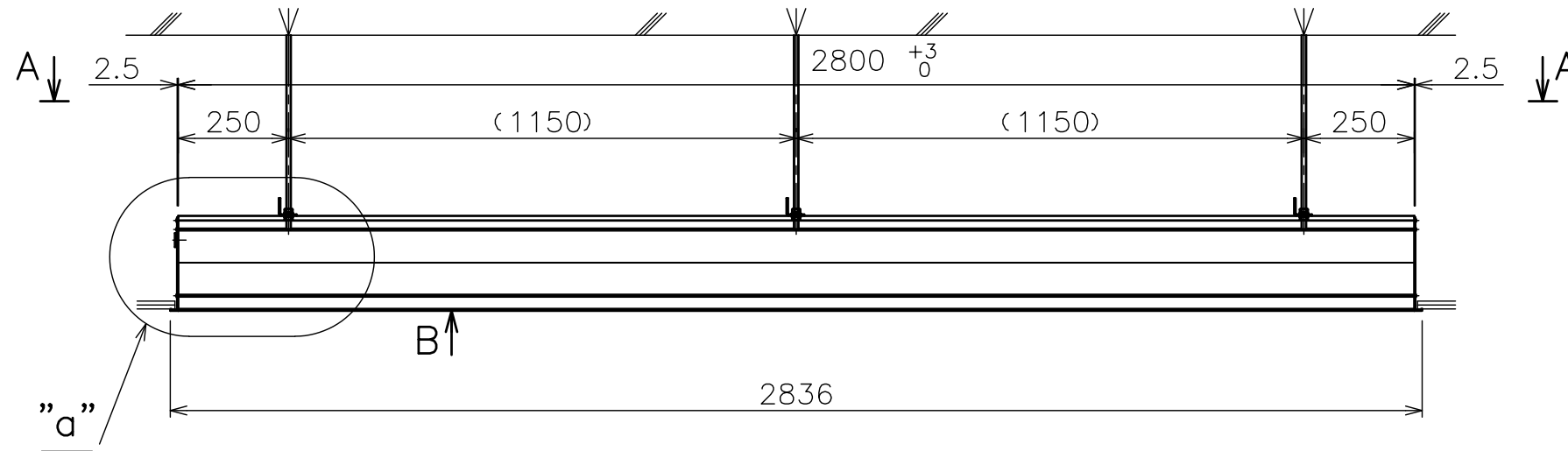

”b”部 M10ボルト挿入口拡大図

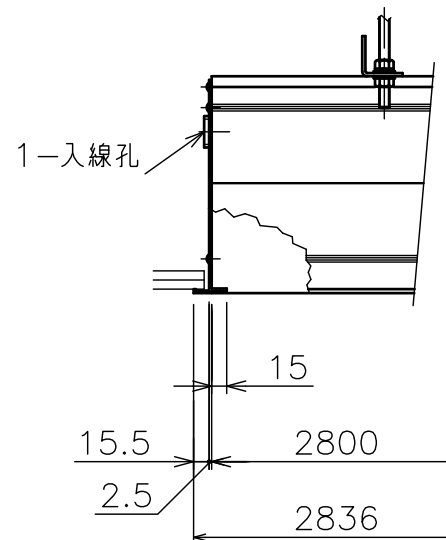

”a”部詳細

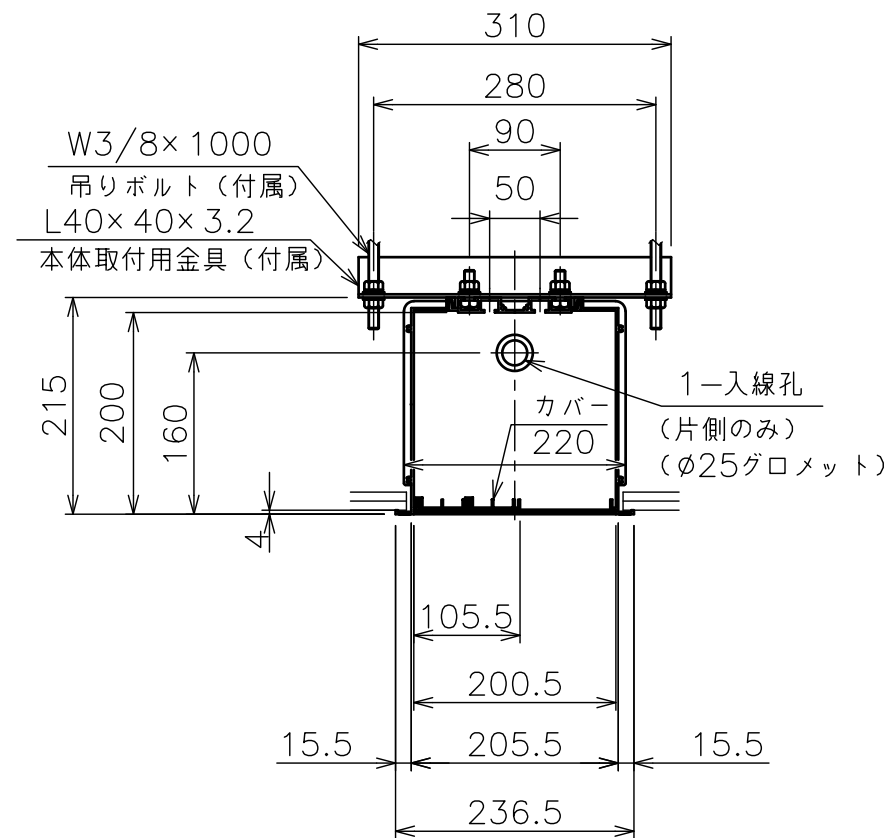

側面図詳細

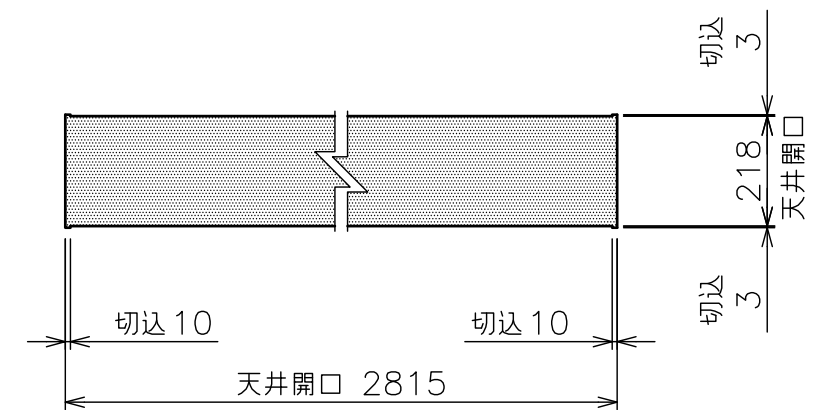

天井開口 KEYPLAN

質量	25.0kg
アルミボックス	A6063SS-T5 日塗IE27-90B相当シルキーホワイト色
備考	